



Wasser erleben

HANSAPINTO

INSTALLATION AND MAINTENANCE GUIDE



Contents

CZ Obsah	FI Sisällysluettelo	IT Indice	PT Conteúdo
DE Inhaltsübersicht	FR Sommaire	NL Inhoud	RU Содержание
DK Indholdsfortegnelse	GR Περιεχόμενα	NO Innhold	SE Innehållsförteckning
ES Contenidos	HU Tartalom	PL Spis treści	SK Obsah



Technical data.....	4
Installation	5
Operation.....	6
Maintenance.....	7-8
Spare parts.....	9

4534 1183

EN 817
50 - 1000 kPa
max. +80°C

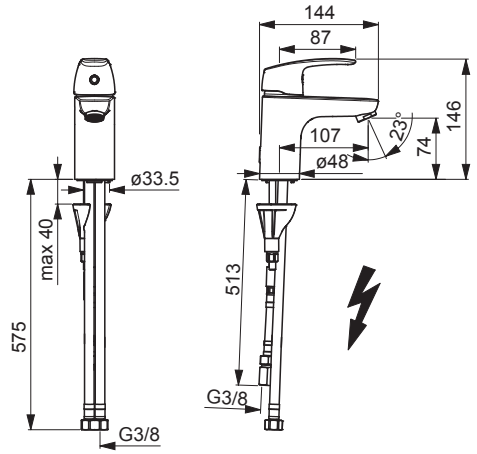

Installation

CZ Montáž

DE Montage

DK Installation

ES Montaje

FI Asennus

FR Installation

GR Συναρμολόγηση

HU Szerelés

IT Montaggio

NL Installatie

NO Montering

PL Instalacja

PT Instruções

RU Установка

SE Installation

SK Inštalácia

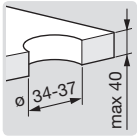
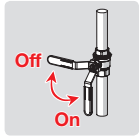

1

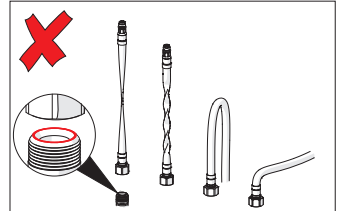
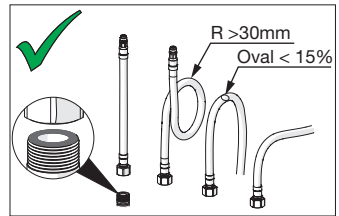
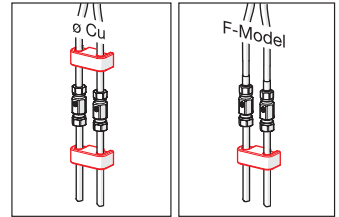
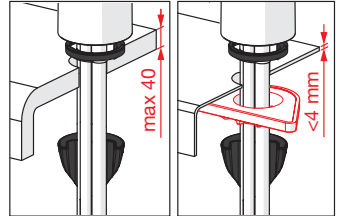
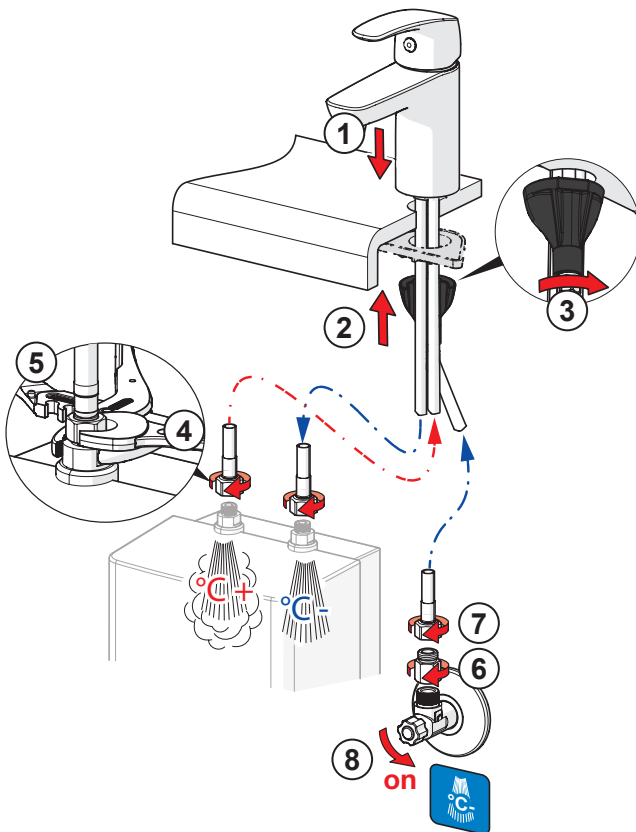

Operation

CZ Funkce
DE Funktion
DK Betjening
ES Servicio

FI Toiminta
FR Utilisation
GR Λειτουργία
HU Üzemeltetés

IT Funzionamento
NL Bediening
NO Funksjon
PL Działanie

PT Funcionamento
RU Принцип действия
SE Funktion
SK Prevádzka

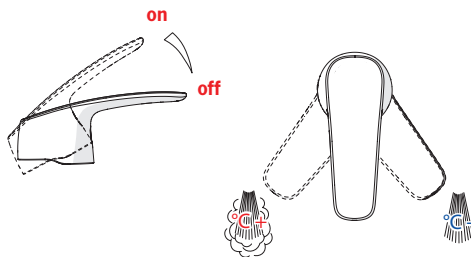

To change the cartridge

CZ Výměna kartuše

DE Auswechseln der Patrone

DK Udsiftingning af reguleringskassette (unit)

ES Montaje del cartucho

FI Säätöosan vaihto

FR Montage et démontage de la cartouche

GR Αντικατάσταση του στοιχείου

HU A patron cseréje

IT Montaggio della cartuccia

NL Vervangen van het keramische binnenwerk

NO Skifting av kassett

PL Wymiana modułu sterującego

PT Substituição do cartucho

RU Замена регулировочного блока

SE Byte av kassett

SK Výměna kartuše

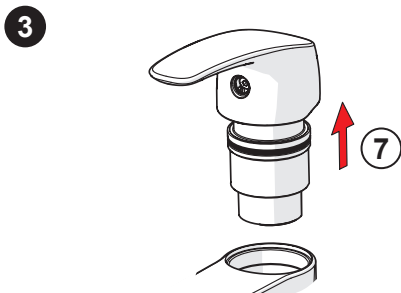
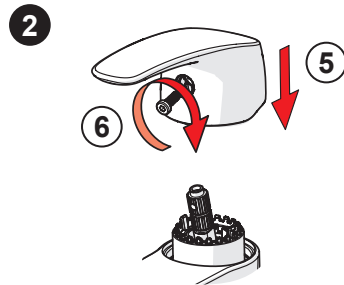
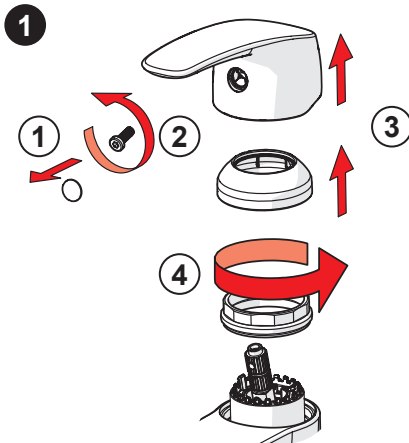
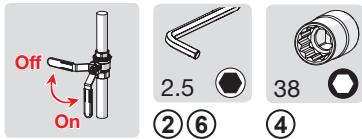

Cleaning the faucet

CZ Čištění baterie

DE Reinigung der Armatur

DK Rengøring af armaturet

ES Limpieza de la grifería

FI Puhdistus

FR Nettoyage du robinet

GR Καθαρισμός του βρύση

HU Takarítás a csapot

IT Pulizia della rubinetteria

NL Reinigen van de kraan

NO Rengjøring av kranen

PL Czyszczenie baterii

PT Limpeza da torneira

RU Чистка смесителя

SE Rengöring av blandarna

SK Čistenie vodovodnej batérie

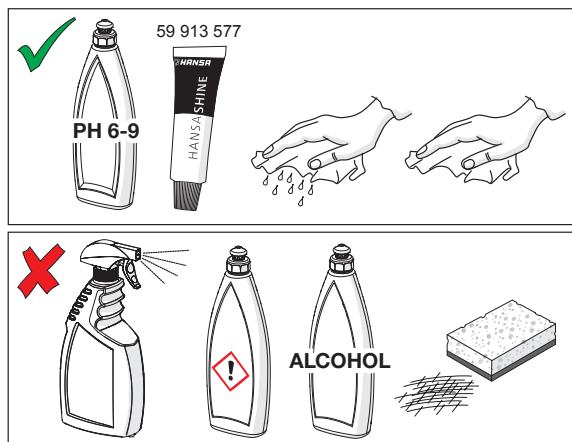

Cleaning/changing the aerator

CZ Čištění/Výměna perlátoru

DE Reinigung/Wechseln des Luftsprudlers

DK Rensning/Udskiftning af perlator

ES Limpieza/Cambiar el aireador

FI Poresuuttimen puhdistaminen/vaihtaminen

FR Nettoyage/Changement de l'aérateur

GR Καθαρισμός/αλλαγή αεριστήρα

HU Az aerátor tisztítása/cseréje

IT Pulizia/Sostituzione dell'aeratore

NL Reinigen/veranderen van de perlator

NO Rensing/Bytting av strålesamler

PL Czyszczenie/Wymiana perlatora

PT Limpar/substituir o arejador

RU Очистка и замена аэратора

SE Rengöring/Byte av strålsamlare

SK Čistenie/Výměna perlátora

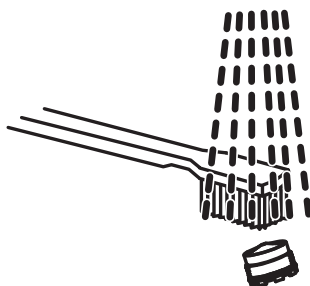

Spare parts

CZ Náhradní díly	FI Varaosat	NL Reserve-onderdelen	RU Запасные части
DE Ersatzteile	FR Pièces détachées	NO Reservedeler	SE Reservdelar
DK Reservedele	HU Alkatrészek	PL Części zamienne	SK Náhradné diely
ES Piezas de recambio	IT Pezzi di ricambio	PT Peças de reposição	

SP45341183

1	59 914 453
2	59 914 478
3	59 914 128
4	59 914 500
5	59 914 474
6	59 914 475
7	59 914 522
8	59 914 085
9	59 914 521
10	59 913 653

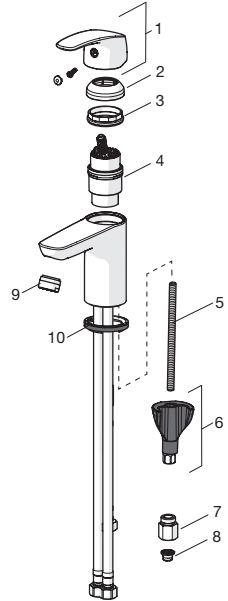

Oras Group is a powerful European provider of sanitary fittings: the market leader in the Nordics and a leading company in Continental Europe. The company's mission is to make the use of water easy and sustainable and its vision is to become the European leader of advanced sanitary fittings. Oras Group has two strong brands, Oras and Hansa.

The head office of the Group is located in Rauma, Finland, and the Group has four manufacturing sites: Burglengenfeld (Germany), Kralovice (Czech Republic), Olesno (Poland) and Rauma (Finland). Oras Group employs approximately 1400 people in twenty countries. Oras Group is owned by Oras Invest, a family company and an industrial owner.

HANSA Armaturen GmbH
P. O. BOX 81 02 40
D-70519 Stuttgart

Sigmaringer Strasse 107
D-70567 Stuttgart
Tel.: +49 711 16 14 0
Fax: +49 711 16 14 368
info@hansa.de

www.hansa.com



a member of  orasgroup