





Mounting and operating instruction
 For article no's starting with AA...FBA08

18.158_02



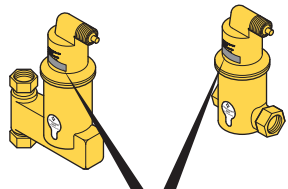



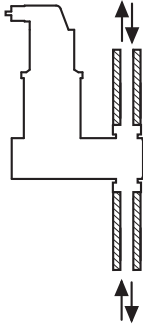

 0- ... bar

 0- ... °C

Acc.PED (97/23/EC) §3.3









 H₂O

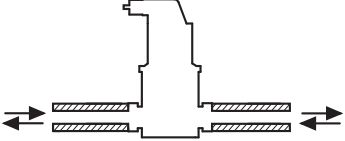

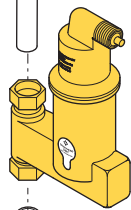

20% < glycol < 50%





ø22mm



 0 bar

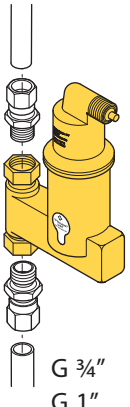

G 3/4"
G 1"

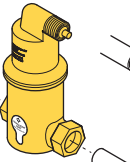
ø22mm



 0 bar

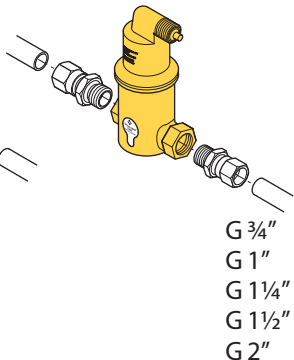

G 3/4"
G 1"
G 1 1/4"
G 1 1/2"
G 2"



 Pmax = 1,5 x ... bar

