

SCHALTBILDER

EZF 30/6 B

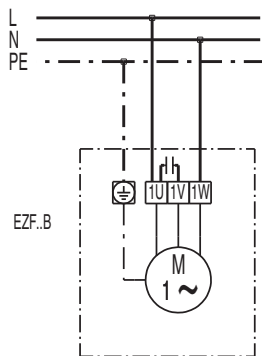
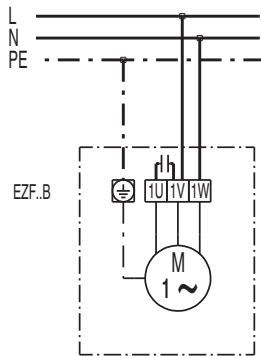

SCHALTBILDER

EZF 30/6 B

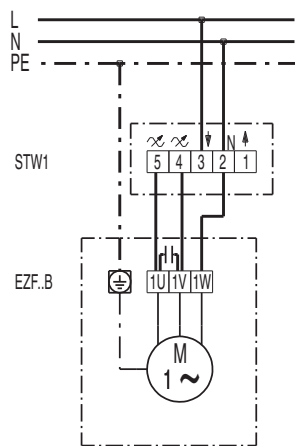
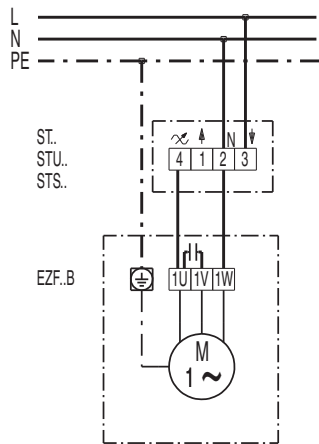

EZF 30/6 B

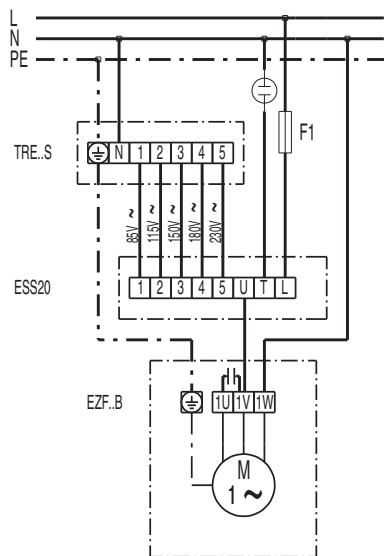
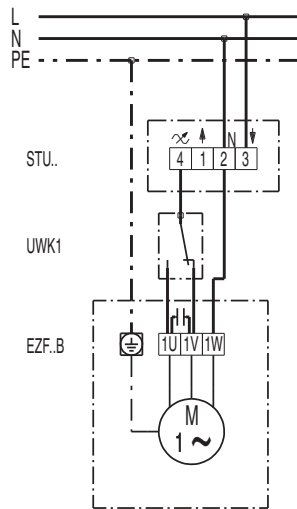

EZF 30/6 B

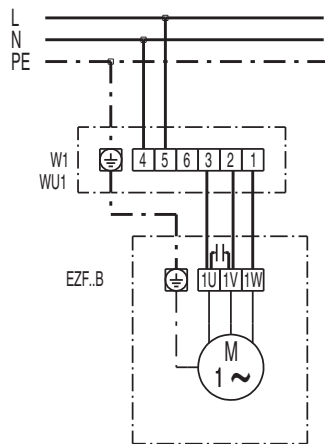
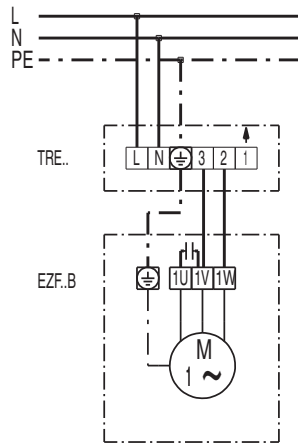

EZF 30/6 B

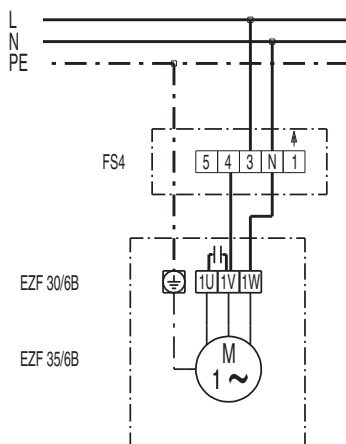
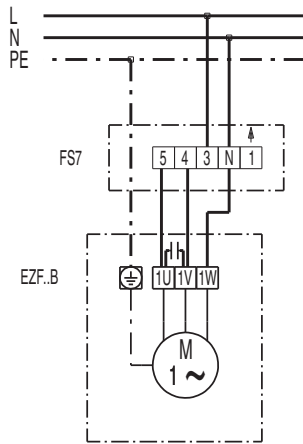

SCHALTBILDER

EZF 30/6 B

