





74.243_00



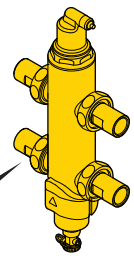

 0 ... bar

 0 ... °C

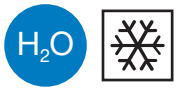
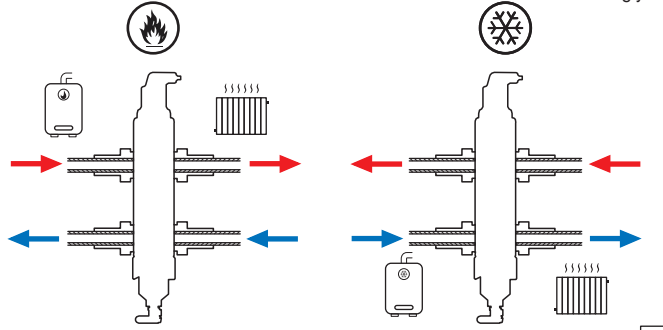

Acc.PED (2014/68/EU §4.3)

1



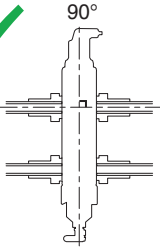

≤ 50% glycol

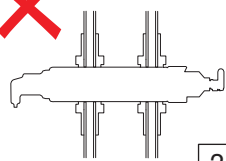
2

3

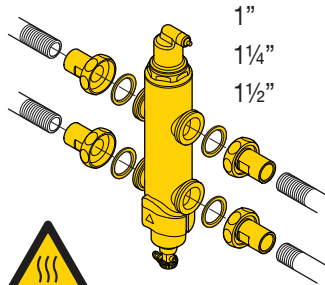



1"
1 1/4"
1 1/2"



0 bar





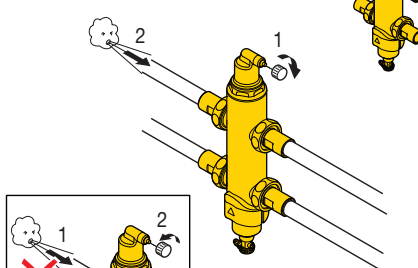
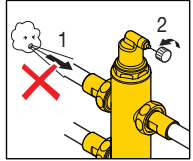

4

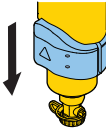
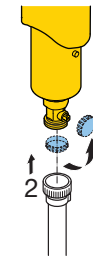

Pmax = 1,5 x ... bar

5

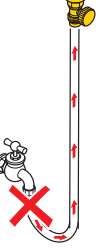
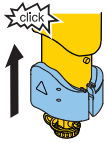
6