



Mounting and operating instruction

For articles with XC...FM



61.962_01





SCAN ME

0-10 bar



0-110 °C

Acc. PED (2014/68/EU) §4.3



Heating system

Cooling system









H₂O

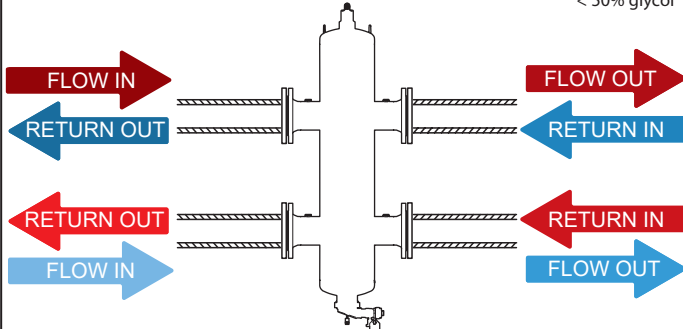

< 50% glycol



0 bar

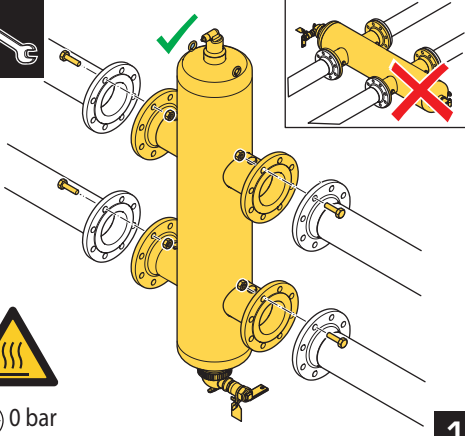

1



Pmax = 15 bar

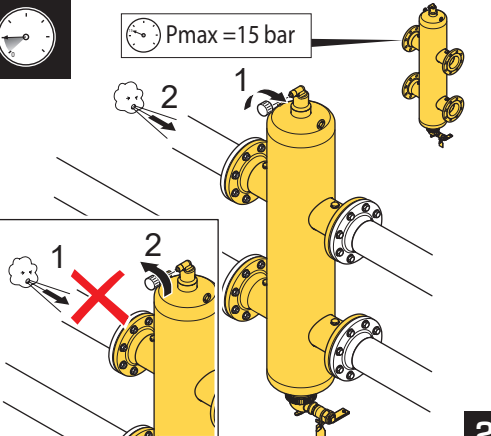

2

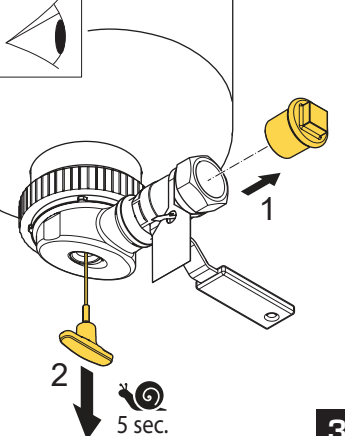

3

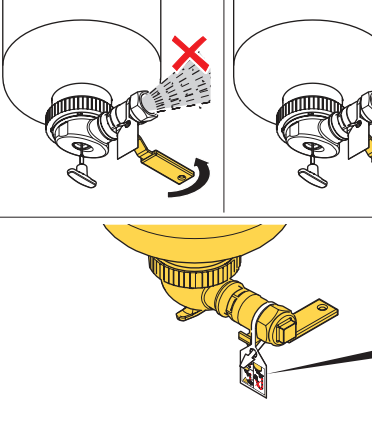



4